

Grinding wheel adapter

and
Accessories



grinding deserves SOLUTIONS

GDS[®]
Made in Germany

Adapters for dressing, presetting etc.

Adapter piece for tool grinding machines, dressing machines, presetting devices, balancing machines

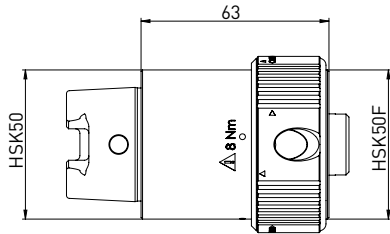

Order No.	Name
350130020	Adapter piece HSK50 on HSK40 A/C/E HSK50 B/D/F

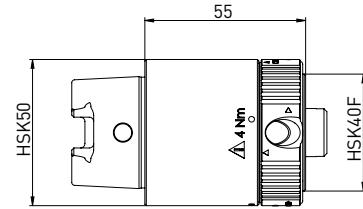

Order No.	Name
350130021	Adapter piece HSK50 on HSK32 A/C/E HSK40 B/D/F

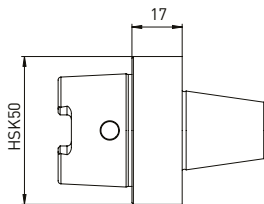

Order No.	Name
350130034	Adapter piece HSK50 on ANCA taper ø30

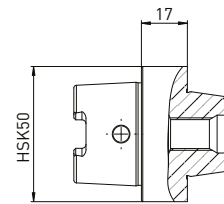

Order No.	Name
350130032	Adapter piece HSK50 on Haas/Walter taper

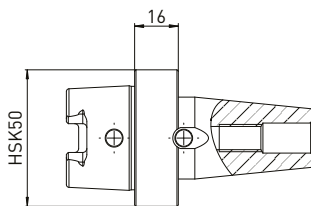

Order No.	Name
350130030	Adapter piece HSK50 on Strausak Fleximat

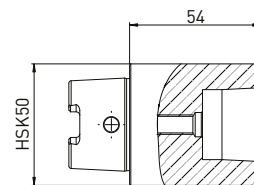

Order No.	Name
350130031	Adapter piece HSK50 on Strausak Promat

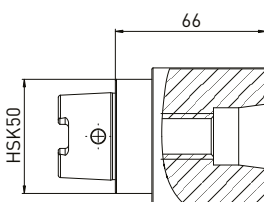

Order No.	Name
350130033	Adapter piece HSK50 on Saacke short taper

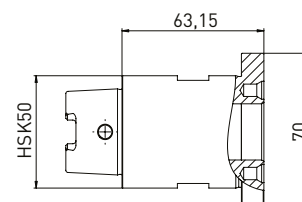

Order No.	Name
350130048	Adapter HSK50 x ø25 on Rollomatic

Adapter for dressing, presetting, balancing

Adapters fine balanced SK40 and SK50 for tool grinding machines, dressing machines, presetting devices, balancing machines

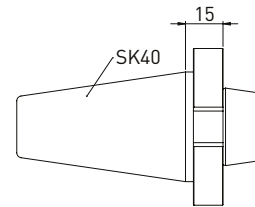
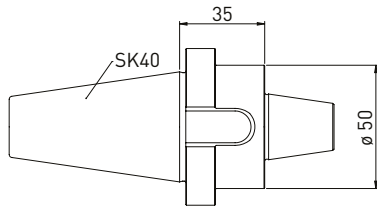

Order No.	Name
350130035	Adapter SK40 on ANCA taper ø30

Order No.	Name
350130014	Adapter SK40 on Haas/Walter taper

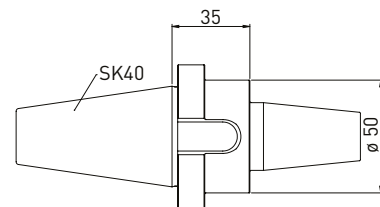
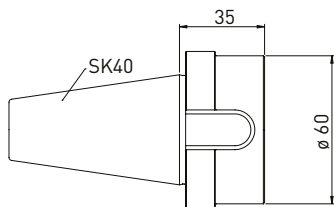

Order No.	Name
350130040	Adapter SK40 on Saacke short taper

Order No.	Name
350130043	Adapter SK40 on Strausak Fleximat

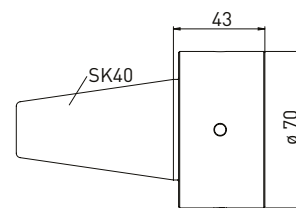
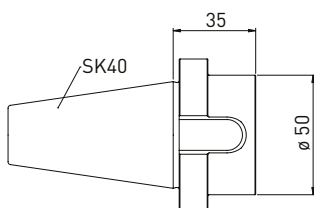

Order No.	Name
350130042	Adapter SK40 on Strausak Promat

Order No.	Name
350130039	Adapter SK40 on Rollomatic ø25

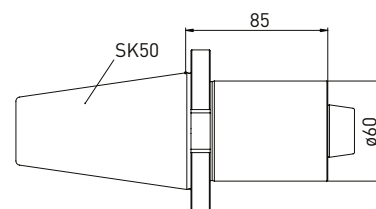
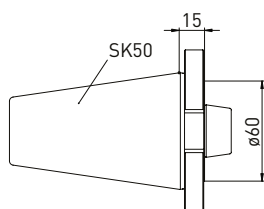

Order No.	Name
350130044	Adapter SK50 on Haas/Walter taper L15

Order No.	Name
350130045	Adapter SK50 on Haas/Walter taper L85

Adapters SK40 and SK50 on HSK tool adapters

Adapter SK40 on HSK

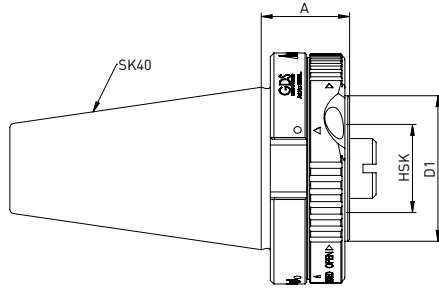

Order No.	A/C/E HSK shape	B/D/F HSK shape	A	D1
350130011	HSK32	HSK40	25	40
350130012	HSK40	HSK50	35	50
350130013	HSK50	HSK63	45	63

Adapter SK50 on HSK

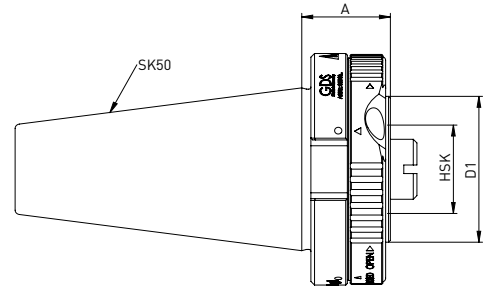

Order No.	A/C/E HSK shape	B/D/F HSK shape	A	D1
350130001	HSK32	HSK40	30	40
350130002	HSK40	HSK50	33	50
350130003	HSK50	HSK63	45	63

*related items

Reduction adapters for grinding wheel adapters

Adapters for grinding wheel adapters from $\varnothing 20$ to $\varnothing 10$ // and $\varnothing 20$ to ER16 collet chuck

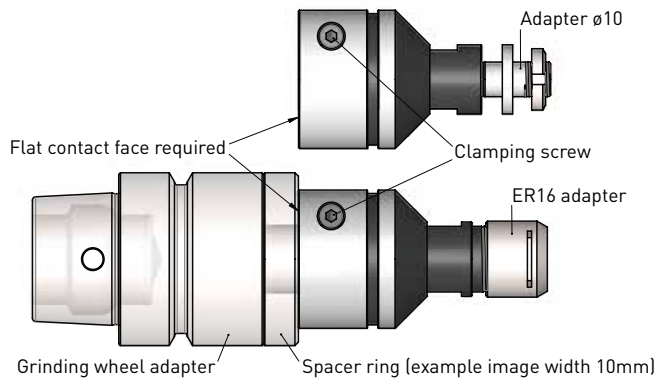

Assembly example

Twist adapter onto M20 x 1 screw and bring to rear to flat contact face.

If needed, lay spacers down first so that the adapter meets the flat contact face.

Subsequently, tighten using spanner flat and secure with clamping screw.

Adapter $\varnothing 20$ on $\varnothing 10$

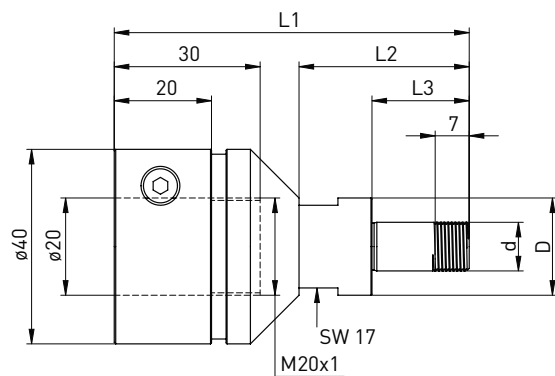

Delivered equipped:

Clamping nut (350020114), Spacer rings 4pc. (350016004)

Order No.	D	d	L1	L2	L3
350130046	20	10	73	35	20

Accessories Adapter $\varnothing 20$ on $\varnothing 10$

Order No.	Name - \varnothing
350016004	Spacer ring $\varnothing 20 \times \varnothing 10 \times 3$
350020114	Clamping nut $\varnothing 18 \times 4 - M10 \times 0,75$
350040050	Hook wrench 16-20 mm

Adapter $\varnothing 20$ on ER16

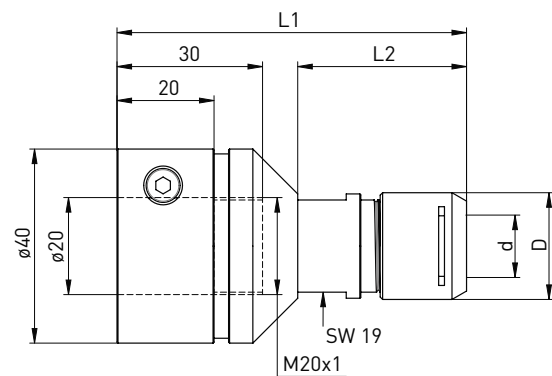

Delivered equipped:

Mini clamping nut Silent ER16 (350020116)

Order No.	D	d	L1	L2
350130047	22	ER16	76	34

Accessories Adapter $\varnothing 20$ on ER16

Order No.	Name
350125116	Mini clamping nut SILENT ER16
350126116	Clamping wrench for Mini clamping nut SILENT ER16

Order No.	Name
3501217**	Collet DIN 6499 ER16 ** $\varnothing 1-10$ mm

**[Please complete the order number with the two-digit number that defines the diameter!] e.g. for $\varnothing 1$ -> last digit 01 (350121701) for $\varnothing 10$ last digit -> 10 (350121710)